

SPECIFICATION OF SURFACE MOUNT TYPE

1 .TYPE	DSX321G
2 .NOMINAL FREQUENCY	24.000000 MHz
3 .LOAD CAPACITANCE(CL)	12.0 pF
4 .DRIVE LEVEL	10 uW +/- 2 uW
5 .FREQUENCY TOLERANCE	+/- 10 x 10 <sup>-6</sup> at 25 deg.C +/- 3 deg.C
6 .SERIES RESISTANCE	60 ohms max. / CL = SERIES
7 .FREQUENCY CHARACTERISTICS OVER TEMPERATURE	+/- 20 x 10 <sup>-6</sup> / -40 deg.C to +85 deg.C (ref. +25 deg.C)
8 .OPERATING TEMPERATURE RANGE	-40 deg.C to +85 deg.C
9 .STORAGE TEMPERATURE RANGE	-40 deg.C to +85 deg.C
10 .SHUNT CAPACITANCE(C0)	2.0 pF max.
11 .INSULATION RESISTANCE	500 Mohms min. at 100V DC
12 .OVERTONE ORDER	Fundamental
13 .DIMENSIONS	Refer to Fig-1

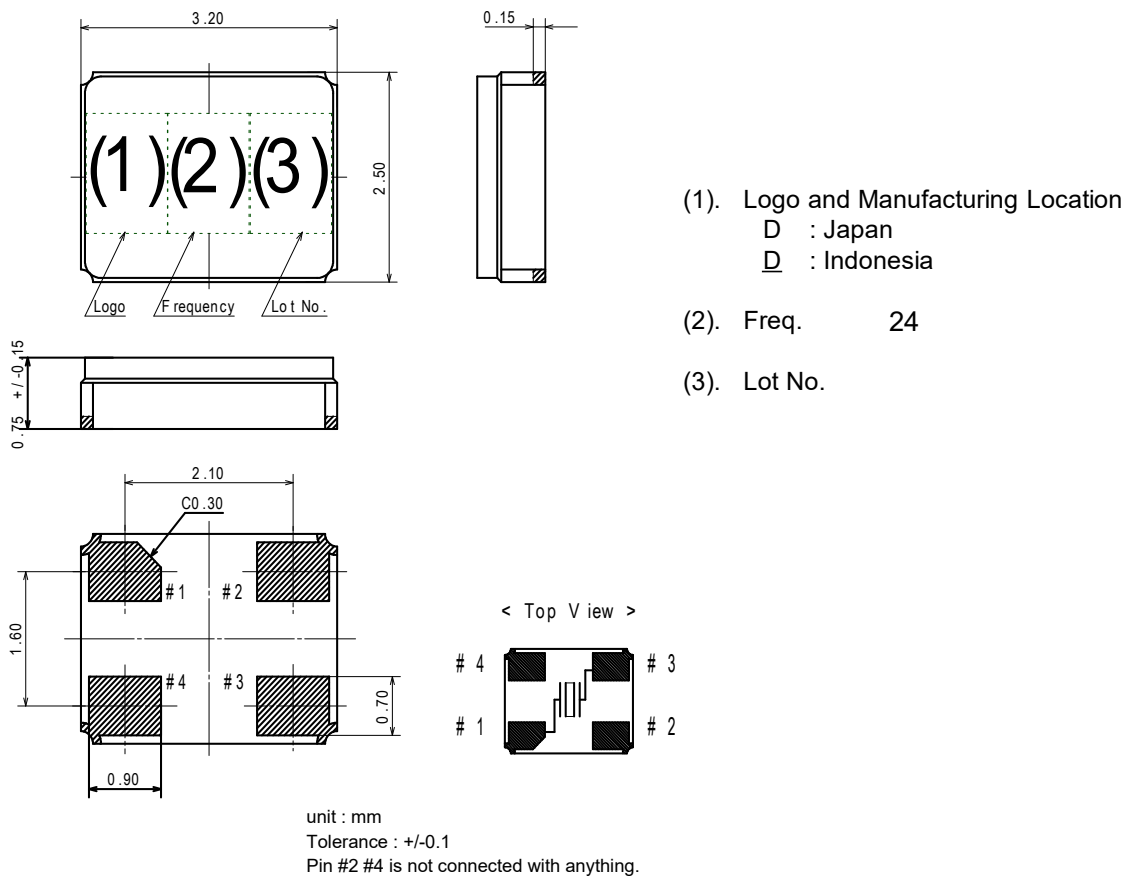

Fig.-1